



Product Information  
Version 2.0

## ZEISS Primovert

Examine and Evaluate Living Cells – Fast and Efficiently



red dot design award  
winner 2010



We make it visible.

## Examine Living Cells – Quickly and Efficiently

- › **In Brief**
- › The Advantages
- › The Applications
- › The System
- › Technology and Details
- › Service

Now you can study the morphography of living cells and evaluate their development with this compact inverted microscope from ZEISS. Primovert is perfectly suited to your cell culture laboratory. It enables fast, efficient investigations of both unstained cells in phase contrast and GFP-labeled cells in fluorescence contrast. It fits straight into your laminar flow cabinet to work directly in a sterile environment.

And it brings you a welcome degree of flexibility, too, with its integrated camera and the Labscope imaging app for iPad: observe your cells from outside the sterile working space and evaluate them with colleagues.

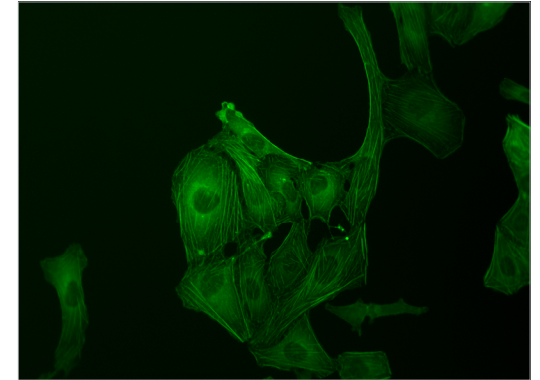

*U2OS cells, GFP-actin stained, 20x objective*



# Simpler. More Intelligent. More Integrated.

- › In Brief
- › **The Advantages**
- › The Applications
- › The System
- › Technology and Details
- › Service

## A Complete Solution for Your Cell Culture Laboratory

Everything about Primovert is designed to facilitate your daily work. Use the switch on the stand to shift effortlessly from phase contrast to fluorescence contrast, evaluating both unstained and GFP-labeled cells. Take your choice of mounting frames to work with various receptacles such as petri dishes and well plates. And when you're using culture flasks, simply remove the condenser to increase the working distance. This compact inverse microscope fits neatly into your laminar flow cabinet so you can work directly in a sterile environment.



## As Rapid as Your Work Flow: Switch It On and Start Evaluating – All Day, Every Day

Your Primovert is always ready to go. Just use the convenient benchtop switch to turn the microscope on and off. Thanks to the integrated LED fluorescence, you start working right away – without warming up or cooling down. When idle, it shuts itself off automatically after 15 minutes – another energy-saving feature. Primovert is easy to use, easy on running costs – and easy on you, too, with an ergotube that lets you find a comfortable working posture and stay relaxed, hour after hour. Adjust the viewing angle to your individual needs and use the microscope in a standing position or seated.



## The Well-Connected Cell Culture Lab

Primovert HDcam is designed for ultimate flexibility: an integrated camera that saves you the hassle of mounting the adapter and camera, or adjusting the settings. Use your iPad and free Labscope imaging app to discuss your images with your team. Primovert HDcam lets you capture microscope images, record videos, create notes and reports, and edit images. Save the files on your Windows network or do some "joined-up" thinking with colleagues via wireless devices. If you prefer, visualize the images on your monitor, projector or laptop.



# Expand Your Possibilities



- › In Brief
- › The Advantages
- › **The Applications**
- › The System
- › Technology and Details
- › Service

## Use Primovert HDcam with Your iPad



Connect one or several iPads simultaneously with Primovert HDcam.

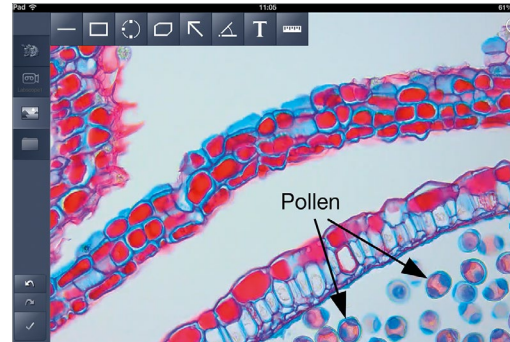

With Labscope, the free iPad imaging app from ZEISS, you can share your live images with several users at once.

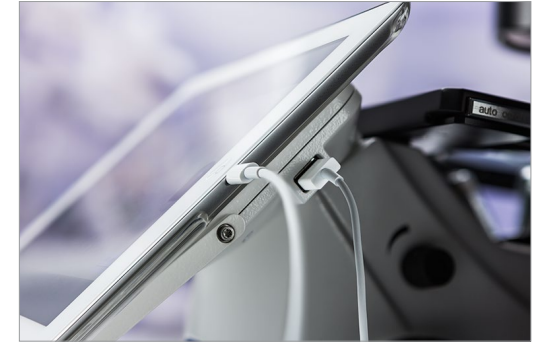

If necessary, you can charge your iPad directly on the stand.

Unleash the functionality of the Labscope imaging app to convert your Primovert into an integrated HD camera with a wireless-enabled imaging system. Whether in the lab or classroom, Labscope makes it easier than ever before to capture images and records videos of your microscope samples. Create notes and reports, edit images and save the files on your Windows network. Or just as easily, share them with colleagues – whenever and wherever you want. The intuitive user interface gets you to work immediately and minimizes the learning curve.

# Expand Your Possibilities

- › In Brief
- › The Advantages
- › **The Applications**
- › The System
- › Technology and Details
- › Service

## Use Primovert HDcam without an iPad



With Primovert HDcam and its integrated five-megapixel camera, you can capture images and record videos directly on the stand. You can also directly adjust recording conditions such as contrast and brightness directly. You can even control the microscope from a different location, using the remote.

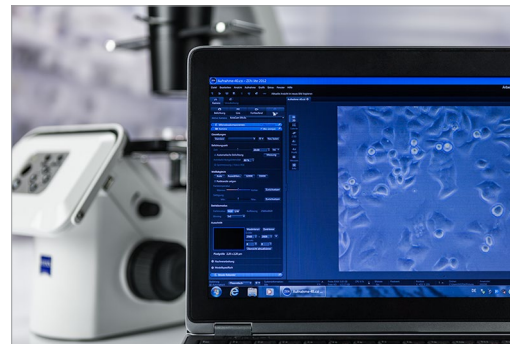

Take advantage of numerous interfaces on Primovert HDcam. The free ZEN lite imaging software provides a flexible means of transferring files to your PC or laptop. Transfer images to a monitor directly in the laminar flow cabinet. Or save your data to an SD card on the stand.



# Expand Your Possibilities

- › In Brief
- › The Advantages
- › **The Applications**
- › The System
- › Technology and Details
- › Service

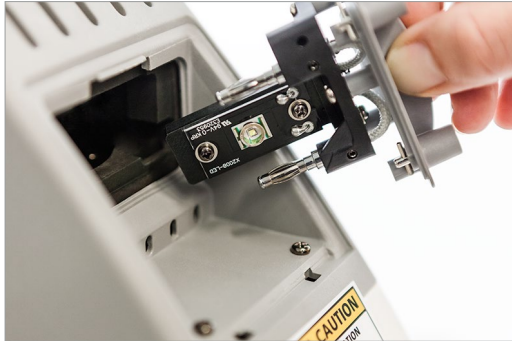

*LED illumination gives you the benefit of long life and stable color temperature. Use LED fluorescence to avoid warming up, cooling down and adjustment of the lamp. Work with constant brightness.*

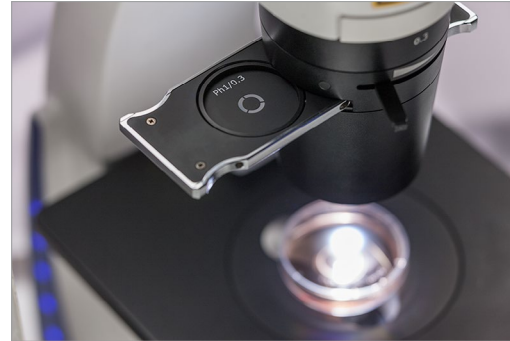

*Primovert has a universal phase slider for all objectives. You can use Ph1 for 10x, 20x and 40x magnification, and avoid having to adjust the phase position when you change the magnification.*

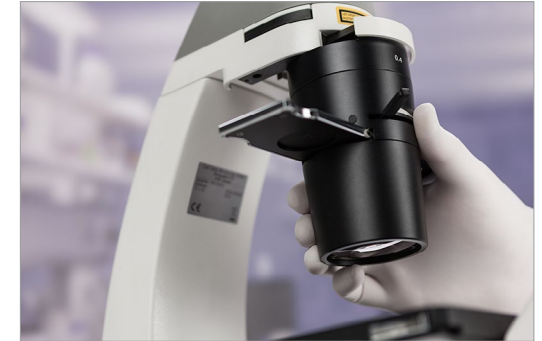

*When working with culture flasks, you can increase the working distance by removing the condenser.*



*Primovert with its adjustable ergotube lets you work in comfort, whether standing or in a seated position.*



*You can use various mounting frames and stage adjustment for flasks and multi-well plates. For many petri dishes, you can also expand the stage.*



*Use the free ZEN lite microscope software to control ZEISS microscope cameras, capture images or view your CZI files.*

# Tailored Precisely to Your Applications

- › In Brief
- › The Advantages
- › **The Applications**
- › The System
- › Technology and Details
- › Service

Typical Applications, Typical Specimens	Task	ZEISS Primovert offers
Primovert applications	Use the nosepiece with multiple objectives to change the magnification 4–40x, phase ring.	Primovert has a 4x nosepiece and a selection of objectives. You can use Plan-Achromat and LD Plan-Achromat objectives with phase ring and magnifications of 4x and 40x.
	Use the microscope to train technical assistants and students.	Primovert HDcam is designed for the joint observation of your results. You can connect one or several microscopes to each other. When using the Labscope imaging app for iPad, you can capture and share images.  Alternatively, you can use Primovert HDcam without an iPad with the help of laptop, projector and SD card interfaces.
	Capture, edit, document and share results—for example, in quality-management.	Primovert HDcam is designed for the joint observation of your results. You can connect one or several microscopes to each other. When using the Labscope imaging app for iPad, you can capture and share images.
	Use the microscope over several hours.	In automatic mode, Primovert operates in standby. If the device is not used for 15 minutes, it automatically shuts itself off. Simply press a button to reactivate it.  The ergotube was designed for extended periods of use. You can adjust the viewing height and angle individually to work comfortably in either a seated or standing position.
	Enable several users to operate the microscope.	Primovert HDcam is designed for the joint observation of your results. You can connect one or several microscopes to each other. When using the Labscope imaging app for iPad, you can capture and share images.
	Evaluate unstained, transparent samples such as living cells.	Primovert is equipped with phase contrast. You use a universal phase slider (Ph0, Ph1, and Ph2) for 10x, 20x, and 40x magnification to eliminate the need for adjusting the phase position when adjusting the magnification.
	Use the microscope in a sterile environment (laminar flow cabinet in cell culture laboratory).	Primovert's compact design enables the microscope to fit into any cell culture laboratory. You can put Primovert HDcam straight in your laminar flow cabinet, control it remotely and connect it to a laptop or monitor, thus working directly in a sterile environment.

# Tailored Precisely to Your Applications

- › In Brief
- › The Advantages
- › **The Applications**
- › The System
- › Technology and Details
- › Service

Typical Applications, Typical Specimens	Task	ZEISS Primovert offers
Primovert applications	Excite and observe the fluorophore GFP.	With Primovert iLED, you can switch between brightfield and fluorescence contrast directly on the stand and evaluate both unstained and GFP-labeled cells.  The LED fluorescence provides even illumination of the sample. You avoid long warming up and cooling down phases as well as lamp adjustments.
	Use various cell culture vessels such as petri dishes, multiwell plates and culture flasks.	Primovert comes with a variety of object guides and stages inserts for different cell culture vessels. Use the stage expansion if you want to stack several vessels on the edge. When working with culture flasks, simply remove the condenser.
	Use petri dishes.	Primovert is an inverted microscope so it's easy to observe cells that collect at the bottom of cell culture vessels from below.



# ZEISS Primovert at Work

- › In Brief
- › The Advantages
- › **The Applications**
- › The System
- › Technology and Details
- › Service

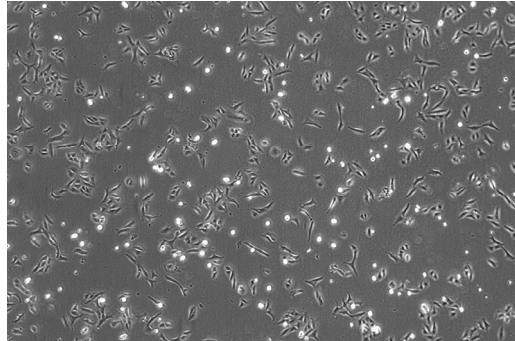

U2OS cells  
Magnification 40x, phase contrast



Formation of conidia in powdery mildew on sage at 40x magnification, courtesy of the Julius Kühn Institute, Braunschweig, Germany

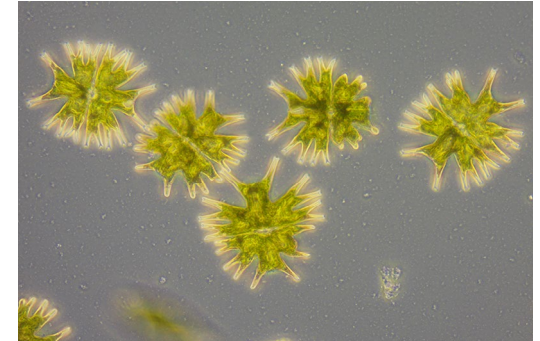

Micrasterias radiata  
Magnification 40x, phase contrast

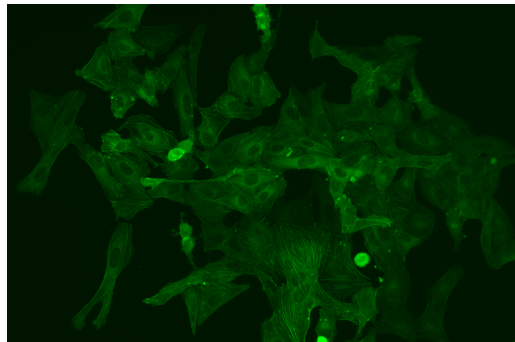

U2OS cells, GFP labeled  
Magnification 20x, fluorescence contrast

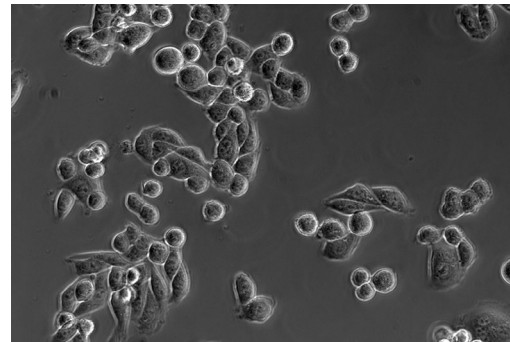

HeLa cells  
Magnification 20x, phase contrast

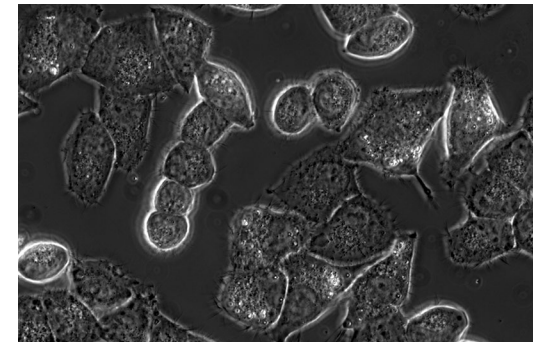

HeLa cells  
Magnification 40x, phase contrast

# Your Flexible Choice of Components

- › In Brief
- › The Advantages
- › The Applications
- › **The System**
- › Technology and Details
- › Service



## 1 Microscopes

- Primovert
- Primovert photo
- Primovert ergo
- Primovert iLED
- Primovert HDcam

## 2 Recommended objectives

- Plan-ACHROMAT 4x/0,10 HF
- Plan-ACHROMAT 4x/0,10 Ph0
- Plan-ACHROMAT 10x/0,25 Ph1
- LD Plan-ACHROMAT 20x/0,30 Ph1
- LD Plan-ACHROMAT 40x/0,50 Ph1
- LD Plan-ACHROMAT 20x/0,30 Ph2
- LD Plan-ACHROMAT 40x/0,50 Ph2

## 3 Condensers

- LD condenser 0.3 (working distance: 72 mm)
- LD condenser 0.4 (working distance: 55 mm)

## 4 Illumination

Transmitted light:

- HAL 30 W (halogen)
- LED

Reflected light:

- 470 nm fluorescence LED
- 38HE filter set

## 5 Cameras

Recommended cameras:

- Axiocam ICc 5
- Axiocam ICc 1
- Axiocam ERc 5s

## 6 Software

- ZEN lite
- Labscope imaging app for iPad

# System Overview of ZEISS Primovert

- › In Brief
- › The Advantages
- › The Applications
- › **The System**
- › Technology and Details
- › Service

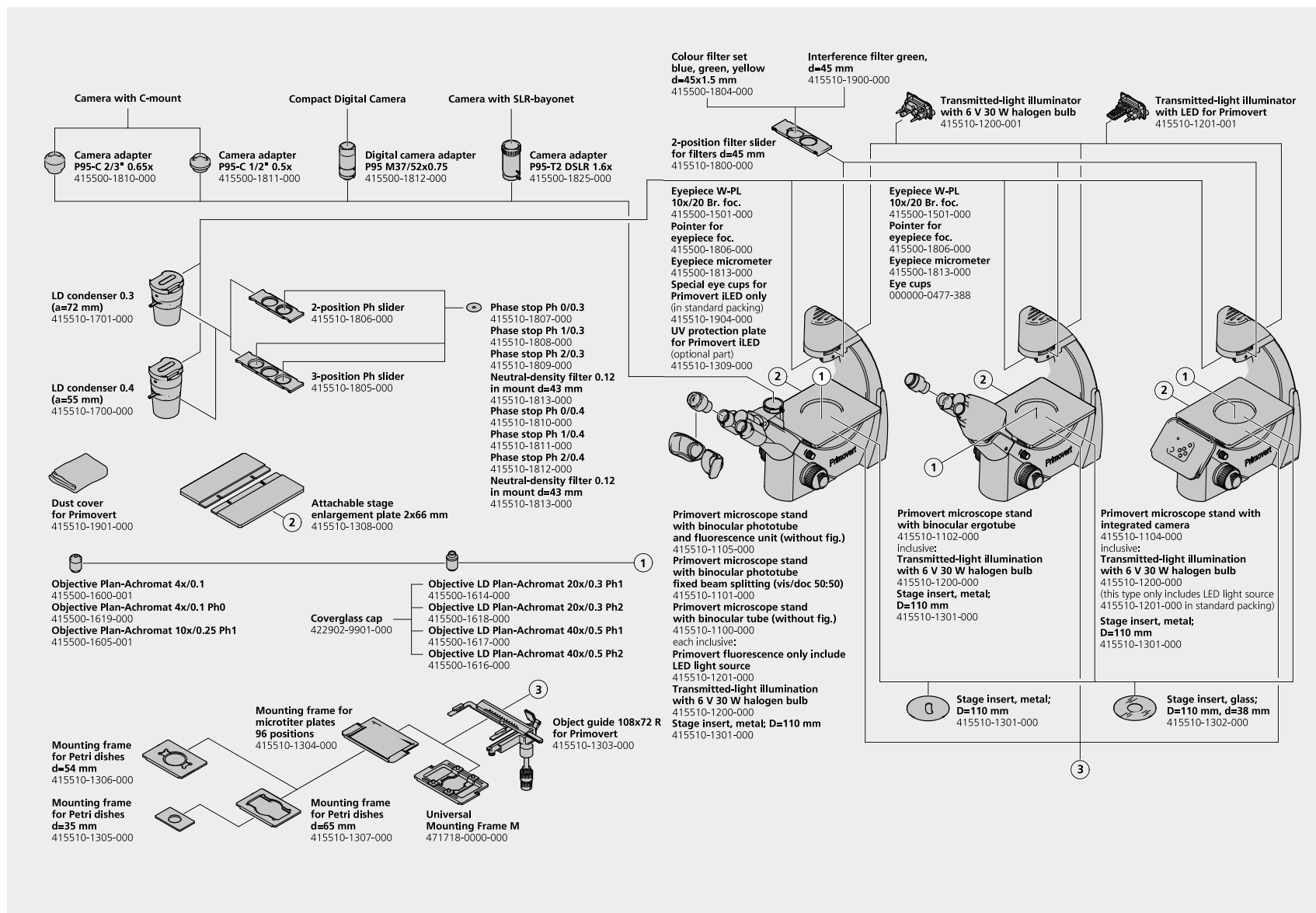

# Specifications

- › In Brief
- › The Advantages
- › The Applications
- › The System
- › **Technology and Details**
- › Service

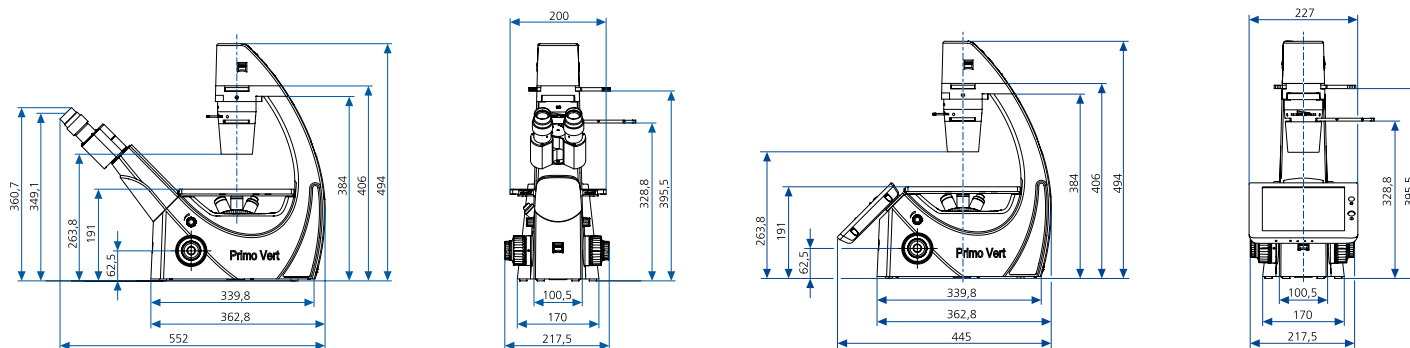

## Dimensions (width × depth × height)

Primovert	Approx. 261 mm × 550 mm × 494 mm
Primovert HDcam	Approx. 215.5 mm × 473 mm × 494 mm
Primovert iLED	Approx. 215.5 mm × 552 mm × 494 mm

## Weight (without accessories or packaging)

Primovert (without accessories or packaging)	Approx. 11 kg
Primovert HDcam	Approx. 11 kg
Primovert iLED	Approx. 11.5 kg

## Ambient conditions

### Transportation (in packaging)

Permissible ambient temperature	-40°C to +70°C
---------------------------------	----------------

### Storage

Permissible ambient temperature	+10°C to +40°C
Permissible humidity	Max. 75% at 35°C (without condensation)

### Operation

Area of use	Closed spaces
Max. altitude	2,000 m
Permissible ambient temperature	+10°C to +40°C
Permissible humidity	Max. 75% at 35°C (without condensation)

# Specifications

- › In Brief
- › The Advantages
- › The Applications
- › The System
- › **Technology and Details**
- › Service

Technical specifications	
Protection class	II
Protection type	IP20
Electrical safety	Pursuant to DIN EN 61010-1 (IEC 61010-1) and in accordance with CSA and UL standards
Degree of pollution	2
Overvoltage category	II
Radio interference suppression	Pursuant to EN 61326-1, EN 61326-2-101
Main voltage	100 to 240 V (±10%); thanks to the worldwide power adapter, adjusting the voltage of the device is not required
Power frequency	50/60 Hz
Power consumption (Primovert HDcam)	45 W; secondary voltage from external 12 V power supply unit
Output power supply unit (Primovert HDcam)	12 V DC; max. 5 A
Power consumption (Primovert iLED)	Max. 30 W; secondary voltage from external 12 V power supply unit
Output power supply (Primovert iLED)	12 V DC; max. 2.5 A
Microscope 12 V/6 V DC	Adjustable 1.5 V to 6 V
LED class of entire device	Risk group 2 pursuant to IEC 62471

## Light sources

<b>Halogen lamp</b>	HAL 6 V, 30 W
Light source adjustment range	Fully adjustable between 1.5 V and 6 V DC
Color temperature at 6 V	2,800 K
Luminous power	765 lm
Average life	100 hours
Illuminated area	1.5 × 1.5 mm



# Specifications

- › In Brief
- › The Advantages
- › The Applications
- › The System
- › **Technology and Details**
- › Service

<b>LED illumination</b>	White-light LED, peak wavelength 450 nm, LED risk group 2 pursuant to IEC 62471
Fluorescent illumination	Blue LED, peak wavelength 470 nm, LED risk group 2 pursuant to IEC 62471
Homogeneous image field illumination	20 mm diameter
Analog brightness adjustment from	Approx. 15 to 100 %
Constant color temperature independent of brightness	7,000 K
Homogeneous image field illumination	20 mm diameter
Analog brightness adjustment from	Approx. 15 to 100 %
With field of view of 20	WF 10x/20 Br. foc.
<b>Optical and mechanical data</b>	
<b>Stand with stage focus</b>	
Using coarse adjustment	45 mm/rev
Using fine adjustment	0.5 mm/rev
Total lift	15 mm
Switching objectives	Manually using 4x nosepiece turret
Objectives	First-class infinity-focus objective range with screw thread W 0.8
Eyepieces with field of view of 20	30 mm plug-in diameter, WF 10x/20 Br. foc.
<b>Object stage</b>	Permanently installed
Dimensions (width x depth)	200 mm x 239 mm
<b>Stage adjustment</b>	Right
Verniers with number and letter scale	X-axis: number scale; read from right to left; y-axis: letter scale, read using the mirror
Coaxial drive	Right
<b>LD condenser 0.3</b>	for Vobj 4x to 40x, a = 72 mm
<b>LD condenser 0.4</b>	for Vobj 4x to 40x, a = 55 mm

# Specifications

- › In Brief
- › The Advantages
- › The Applications
- › The System
- › **Technology and Details**
- › Service

<b>ZEISS Primovert</b>	
Maximum field of view	20
Eyepiece distance (pupil distance)	Adjustable from 48 to 75 mm
Viewing angle	45°
Viewing height	350 to 390 mm
Visual output	Tube factor 1×

<b>ZEISS Primovert photo</b>	
Viewing height	350 to 390 mm
Visual output	Tube factor 1×
Photo/video output	Tube factor 1×, interface 60 mm
Fixed split	50% vis, 50% doc

<b>ZEISS Primovert ergo</b>	
Maximum field of view	20
Eyepiece distance (pupil distance)	Adjustable from 48 to 75 mm
Viewing angle	30° to 60°, infinitely adjustable
Viewing height	360 to 480 mm
Visual output	Tube factor 1×

<b>ZEISS Primovert HDcam*</b>	
Camera	5-megapixel CMOS
Acquired field of view of the camera	11.4 mm × 8.56 mm (14.2 mm diagonal)
Integrated camera adapter	0.63×
Output	HDMI/USB 2.0/Ethernet port/SD card
iPad mount	Tiltable from 40° to 80°

\* The images from Primovert HDcam should not be used for making a direct diagnosis.

# Specifications

- › In Brief
- › The Advantages
- › The Applications
- › The System
- › **Technology and Details**
- › Service

## Primovert iLED

Maximum field of view	20
Illumination	Epi-fluorescence/transmitted light
Fluorescence source	LED wavelength 470 nm
Transmitted light source	LED 7,000 K
Eyepiece distance (pupil distance)	Adjustable from 48 to 75 mm
Viewing angle	45°
Viewing height	350 to 390 mm
Visual output	Tube factor 1x
Photo/video port	
Fixed beam splitting	

# Count on Service in the True Sense of the Word

- › In Brief
- › The Advantages
- › The Applications
- › The System
- › Technology and Details
- › **Service**

Because the ZEISS microscope system is one of your most important tools, we make sure it is always ready to perform. What's more, we'll see to it that you are employing all the options that get the best from your microscope. You can choose from a range of service products, each delivered by highly qualified ZEISS specialists who will support you long beyond the purchase of your system. Our aim is to enable you to experience those special moments that inspire your work.

## **Repair. Maintain. Optimize.**

Attain maximum uptime with your microscope. A ZEISS Protect Service Agreement lets you budget for operating costs, all the while reducing costly downtime and achieving the best results through the improved performance of your system. Choose from service agreements designed to give you a range of options and control levels. We'll work with you to select the service program that addresses your system needs and usage requirements, in line with your organization's standard practices.

Our service on-demand also brings you distinct advantages. ZEISS service staff will analyze issues at hand and resolve them – whether using remote maintenance software or working on site.

## **Enhance Your Microscope System.**

Your ZEISS microscope system is designed for a variety of updates: open interfaces allow you to maintain a high technological level at all times. As a result you'll work more efficiently now, while extending the productive lifetime of your microscope as new update possibilities come on stream.



*Profit from the optimized performance of your microscope system with services from ZEISS – now and for years to come.*

>> [www.zeiss.com/microservice](http://www.zeiss.com/microservice)



**Carl Zeiss Microscopy GmbH**  
07745 Jena, Germany  
microscopy@zeiss.com  
www.zeiss.com/primovert



We make it visible.