

## USEPA<sup>1</sup> FerroVer<sup>®</sup> Method<sup>2</sup>

Method 8008

0.02 to 5.00 mg/L Fe

Powder Pillows or AccuVac<sup>®</sup> Ampuls

**Scope and application:** For water, wastewater and seawater; digestion is required for determining total iron.

<sup>1</sup> USEPA approved for reporting wastewater analysis, Federal Register, June 27, 1980; 45 (126:43459).

<sup>2</sup> Adapted from Standard Methods for the Examination of Water and Wastewater.



### Test preparation

#### Before starting

To make sure that all forms of the metal are measured, digest the sample with heat and acid. Use the mild or vigorous digestion. Refer to the *Water Analysis Guide* for more information.

For turbid samples, treat the blank with one 0.1-g scoop of RoVer Rust Remover. Swirl to dissolve.

Always do tests in sample cells or AccuVac<sup>®</sup> Ampuls. Do not put the instrument in the sample or pour the sample into the cell holder.

Make sure that the sample cells are clean and there are no scratches where the light passes through them.

Rinse the sample cell and cap with the sample three times before the sample cell is filled.

Make sure that there are no fingerprints or liquid on the external surface of the sample cells or AccuVac<sup>®</sup> Ampuls. Wipe with a lint-free cloth before measurement.

Cold waters can cause condensation on the sample cell or bubbles in the sample cell during color development. Examine the sample cell for condensation or bubbles. Remove condensation with a lint-free cloth. Invert the sample cell to remove bubbles.

Install the instrument cap over the cell holder before ZERO or READ is pushed.

After the test, immediately empty and rinse the sample cell. Rinse the sample cell and cap three times with deionized water.

For the best results, measure the reagent blank value for each new lot of reagent. Replace the sample with deionized water in the test procedure to determine the reagent blank value. Subtract the reagent blank value from the sample results.

Review the Safety Data Sheets (MSDS/SDS) for the chemicals that are used. Use the recommended personal protective equipment.

Dispose of reacted solutions according to local, state and federal regulations. Refer to the Safety Data Sheets for disposal information for unused reagents. Refer to the environmental, health and safety staff for your facility and/or local regulatory agencies for further disposal information.

#### Items to collect

##### Powder pillows

Description	Quantity
FerroVer <sup>®</sup> Iron Reagent Powder Pillows, 10-mL <sup>1</sup>	1
Sample cells, 25-mm (10 mL)	2

Refer to Consumables and replacement items on page 6 for order information.

<sup>1</sup> FerroVer is a registered trademark of Hach Company.

## AccuVac Ampuls

Description	Quantity
FerroVer <sup>®</sup> Iron Reagent AccuVac <sup>®</sup> Ampul	1
Beaker, 50-mL	1
Stopper for 18-mm tubes and AccuVac Ampuls	1
Sample cells, 25-mm (10 mL)	1

Refer to Consumables and replacement items on page 6 for order information.

## Sample collection and storage

- Collect samples in clean glass or plastic bottles that have been cleaned with 6 N (1:1) hydrochloric acid and rinsed with deionized water.
- To measure only dissolved iron, filter the sample immediately after collection and before acidification.
- To preserve samples for later analysis, adjust the sample pH to less than 2 with concentrated nitric acid (approximately 2 mL per liter). No acid addition is necessary if the sample is tested immediately.
- Keep the preserved samples at room temperature for a maximum of 6 months.
- Before analysis, adjust the pH to 3–5 with 5 N sodium hydroxide solution.
- Correct the test result for the dilution caused by the volume additions.

## Powder pillow procedure

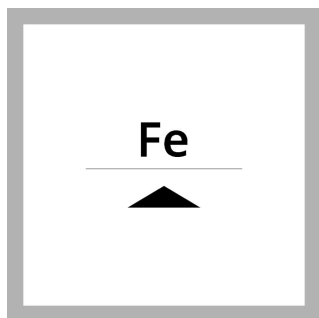

**1.** Set the instrument to iron (Fe).

For DR300, push the up arrow button. For PCII, push the menu button, checkmark button, then the menu button again.

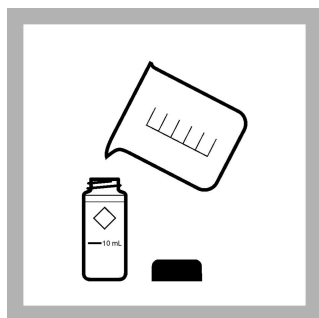

**2. Prepare the sample:** Rinse a sample cell and cap three times with sample. Fill the sample cell to the 10-mL mark with sample.

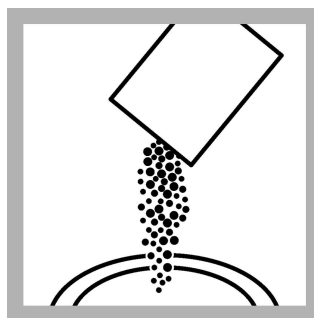

**3.** Add one FerroVer Iron Reagent Powder Pillow to the sample cell.

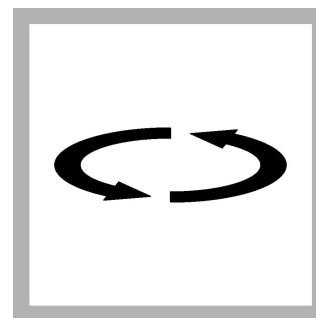

**4.** Swirl to mix.



5. Set and start a timer for 3 minutes. A 3-minute reaction time starts.

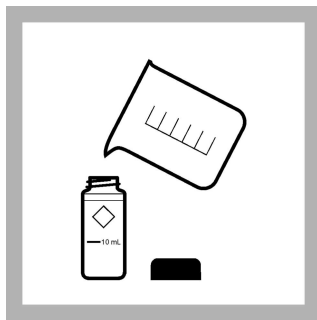

6. **Prepare the blank:** Rinse a sample cell and cap three times with sample. Fill the sample cell to the 10-mL mark with sample. Close the sample cell.

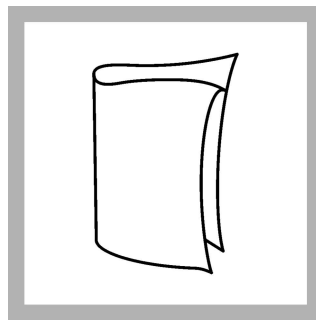

7. When the timer expires, clean the blank sample cell.

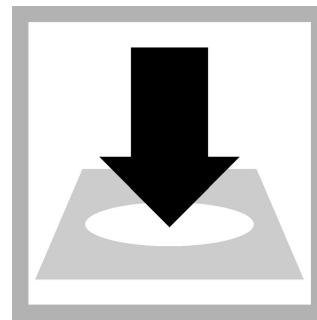

8. Insert the blank into the cell holder. Point the diamond mark on the sample cell toward the keypad.

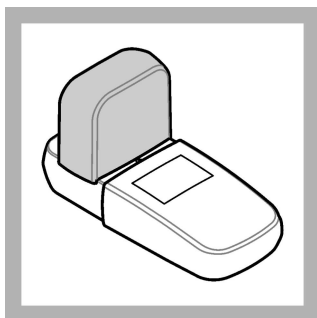

9. Install the instrument cap over the cell holder.

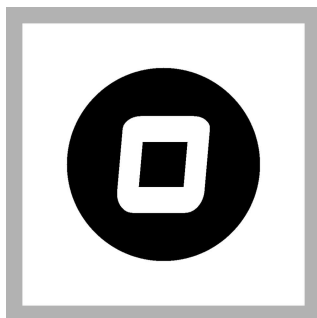

10. Push **ZERO**. The display shows "0.00".

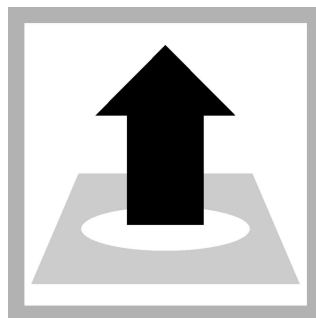

11. Remove the sample cell from the cell holder.

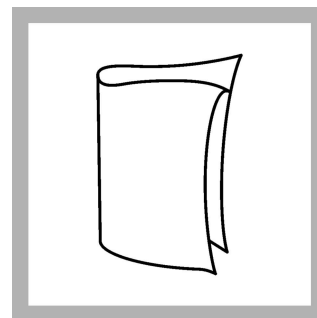

12. Clean the prepared sample cell.

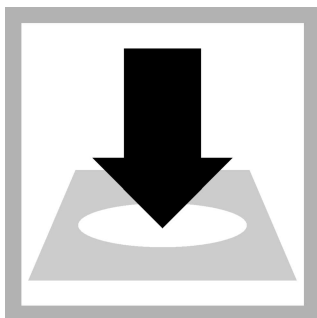

13. Within 5 minutes after the timer expires, insert the prepared sample into the cell holder. Point the diamond mark on the sample cell toward the keypad.

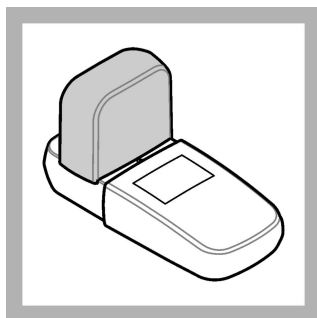

14. Install the instrument cap over the cell holder.

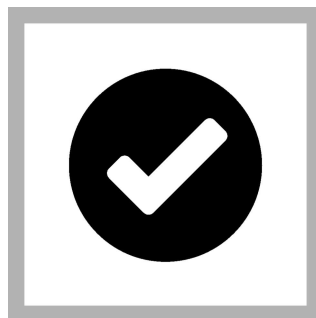

15. Push **READ**. Results show in mg/L iron.

## AccuVac<sup>®</sup> Ampul procedure

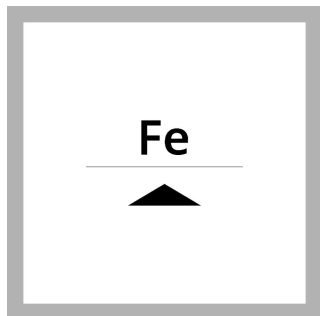

**1. Set the instrument to iron (Fe).**

For DR300, push the up arrow button. For PCII, push the menu button, checkmark button, then the menu button again.

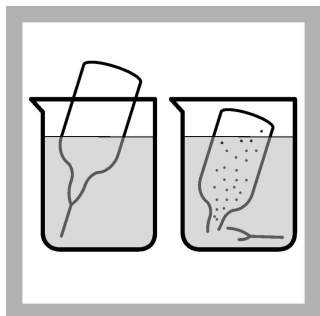

**2. Prepare the sample:** Collect at least 40 mL of sample in a 50-mL beaker. Fill the AccuVac Ampul with sample. Keep the tip immersed while the AccuVac Ampul fills completely.

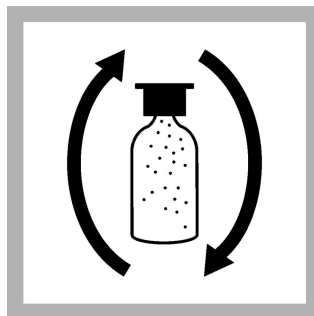

**3. Quickly invert the AccuVac Ampul several times to mix.**

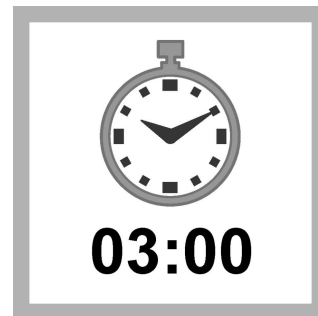

**4. Set and start a timer for 3 minutes. A 3-minute reaction time starts.**

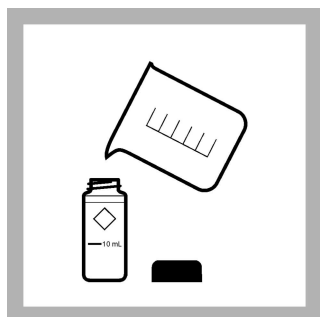

**5. Prepare the blank:** Rinse a sample cell and cap three times with sample. Fill the sample cell to the 10-mL mark with sample. Close the sample cell.

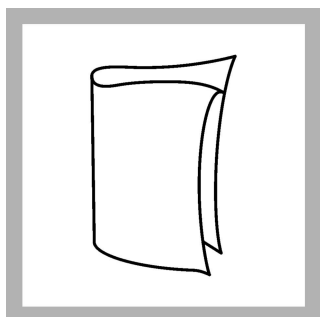

**6. Clean the blank sample cell.**

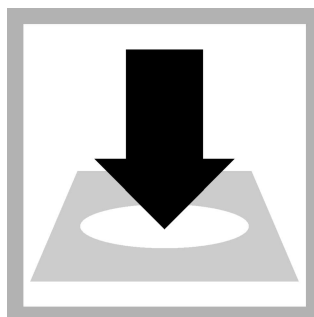

**7. Insert the blank into the cell holder. Point the diamond mark on the sample cell toward the keypad.**

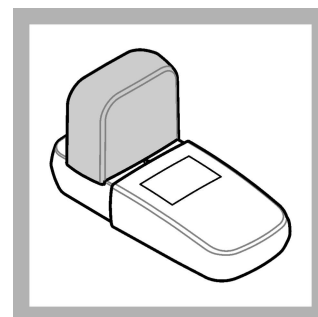

**8. Install the instrument cap over the cell holder.**

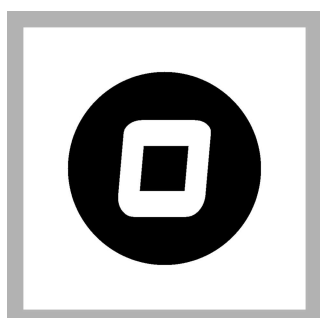

**9. Push ZERO.** The display shows "0.00".

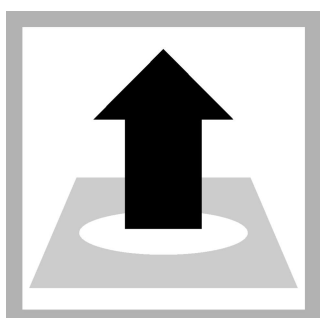

**10. Remove the sample cell from the cell holder.**

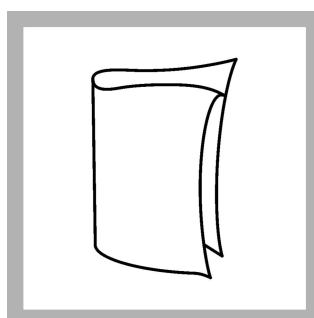

**11. Clean the AccuVac Ampul.**

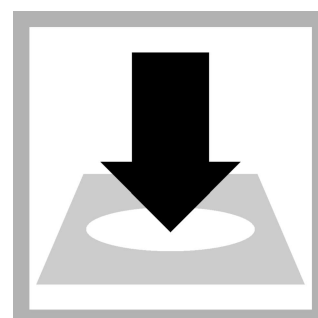

**12. Within 5 minutes after the timer expires, insert the prepared sample AccuVac Ampul into the cell holder.**

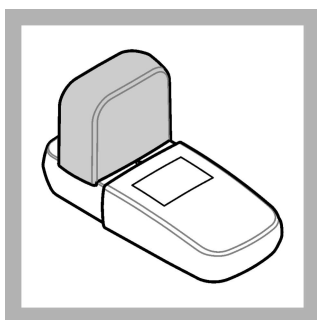

13. Install the instrument cap over the cell holder.



14. Push **READ**. Results show in mg/L iron.

## Interferences

Interfering substance	Interference level
Calcium, Ca <sup>2+</sup>	No effect at less than 10,000 mg/L as CaCO <sub>3</sub> .
Chloride, Cl <sup>-</sup>	No effect at less than 185,000 mg/L.
Copper, Cu <sup>2+</sup>	No effect. Masking agent is contained in FerroVer Reagent.
High iron levels	Inhibit color development. Dilute sample and re-test to verify results.
Iron oxide	A mild, vigorous or Digesdahl digestion is necessary. After digestion, adjust the sample pH to 3–5 with sodium hydroxide, then analyze.
Magnesium	No effect at 100,000 mg/L as CaCO <sub>3</sub> .
Molybdate molybdenum	No effect at 50 mg/L as Mo.
High sulfide levels, S <sup>2-</sup>	<p>Pretreat the sample in a fume hood or in an area with sufficient airflow before analysis:</p> <ol style="list-style-type: none"> <li>1. Add 5 mL of 6.0 N (1:1) hydrochloric acid solution to 100 mL of sample in a 250-mL Erlenmeyer flask.</li> <li>2. Boil for 20 minutes.</li> <li>3. Let the solution cool to room temperature.</li> <li>4. Adjust the pH to 3–5 with 5 N sodium hydroxide solution.</li> <li>5. Add deionized water until the volume is 100 mL.</li> <li>6. Use the treated sample in the test procedure.</li> </ol>
Turbidity	<p>Pre-treat the sample before analysis:</p> <ol style="list-style-type: none"> <li>1. Add one 0.1-g scoop of RoVer<sup>®</sup> Rust Remover to the blank. Swirl to mix.</li> <li>2. If the sample remains turbid, add three 0.2-g scoops of RoVer Rust Remover to 75 mL of sample. Let stand 5 minutes.</li> <li>3. Filter through a 0.45-micron membrane filter and filter holder.</li> <li>4. Use the treated sample in the test procedure.</li> </ol>
Highly buffered samples or extreme sample pH	Can prevent the correct pH adjustment (of the sample) by the reagents. Sample pretreatment may be necessary. Adjust the pH to 3–5.

## Accuracy check

### Standard additions method

Use the standard additions method to validate the test procedure, reagents and instrument and to find if there is an interference in the sample.

Items to collect:

- Iron Standard Solution, PourRite™ Ampules, 50 mg/L, 2 mL
- Ampule breaker
- Pipet, TenSette®, 0.1–1.0 mL and tips
- Mixing cylinders (3)

1. Prepare three spiked samples: use the TenSette pipet to add 0.1 mL, 0.2 mL and 0.3 mL of the standard solution, respectively, to three 25-mL portions of fresh sample. Mix well.
2. Use the test procedure to measure the concentration of each of the spiked samples. Start with the smallest sample spike. Measure each of the spiked samples in the instrument.
3. Compare the expected result to the actual result. The iron concentration should increase 0.2 mg/L for each 0.1 mL of standard added.

### Standard solution method

Use the standard solution method to validate the test procedure, the reagents and the instrument.

Items to collect:

- Iron standard solution, 100 mg/L
- 100-mL volumetric flask, Class A
- 3-mL volumetric pipet, Class A and pipet filler
- Deionized water

1. Prepare a 3.00-mg/L iron standard solution as follows:
  - a. Use a pipet to add 3 mL of the 100-mg/L iron standard solution into the volumetric flask.
  - b. Dilute to the mark with deionized water. Mix well. Prepare this solution daily.
2. Use the test procedure to measure the concentration of the prepared standard solution.
3. Compare the expected result to the actual result.

**Note:** The factory calibration can be adjusted slightly with the standard calibration adjust option so that the instrument shows the expected value of the standard solution. The adjusted calibration is then used for all test results. This adjustment can increase the test accuracy when there are small variations in the reagents or instruments.

### Method performance

The method performance data that follows was derived from laboratory tests that were measured on a DR300 and a Pocket Colorimeter II during ideal test conditions. Users can get different results under different test conditions.

Precision (95% confidence interval)
1.00 ± 0.2 mg/L Fe

### Summary of method

FerroVer Iron Reagent converts all soluble iron and most insoluble forms of iron in the sample to soluble ferrous iron. The ferrous iron reacts with the 1-10 phenanthroline indicator in the reagent to form an orange color in proportion to the iron concentration.

### Consumables and replacement items

#### Required reagents

Description	Quantity/Test	Unit	Item no.
FerroVer <sup>®</sup> Iron Reagent Powder Pillow <sup>2</sup> , 10 mL	1	100/pkg	2105769
OR			
FerroVer <sup>®</sup> Iron Reagent AccuVac <sup>®</sup> Ampul	1	25/pkg	2507025

<sup>2</sup> FerroVer is a registered trademark of Hach Company

**Required apparatus (powder pillows)**

Description	Quantity/test	Unit	Item no.
Sample cells, 10-mL round, 25 mm x 60 mm	2	6/pkg	2427606

**Required apparatus (AccuVac Ampul)**

Description	Quantity/Test	Unit	Item no.
Sample cell, 10-mL round, 25 mm x 60 mm	1	6/pkg	2427606
Beaker, 50 mL	1	each	50041H
Stoppers for 18-mm tubes and AccuVac Ampuls	2	6/pkg	173106

**Recommended standards and apparatus**

Description	Unit	Item no.
Flask, volumetric, Class A, 100 mL, glass	each	1457442
Iron Standard Solution, PourRite™ Ampules, 50 mg/L, 2 mL	20/pkg	1425420
Iron Standard Solution, 100-mg/L Fe	100 mL	1417542
Metals Drinking Water Standard, LR for Cu, Fe, Mn	500 mL	2833749
Metals Drinking Water Standard, HR for Cu, Fe, Mn	500 mL	2833649
Pipet filler, safety bulb	each	1465100
Pipet, TenSette®, 0.1–1.0 mL	each	1970001
Pipet tips for TenSette® Pipet, 0.1–1.0 mL	50/pkg	2185696
Pipet tips for TenSette® Pipet, 0.1–1.0 mL	1000/pkg	2185628
Pipet, volumetric, Class A, 3 mL	each	1451503
Water, deionized	4 L	27256

**Optional reagents and apparatus**

Description	Unit	Item no.
<b>AccuVac® Ampul Snapper</b>	<b>each</b>	<b>2405200</b>
Mixing cylinder, graduated, 50 mL	each	189641
Filter, glass fiber membrane, 1.5-micron, 47-mm	100/pkg	253000
Filter membrane filter holder, 47-mm	each	234000
Ammonium Hydroxide, ACS	500 mL	10649
Hydrochloric Acid Solution, 6.0 N (1:1)	60 mL	L247.0060
Hydrochloric Acid Solution, 6.0 N (1:1)	1000 mL	L247.1000
Hydrochloric Acid, concentrated	500 mL	13449
Nitric Acid, concentrated	500 mL	15249
Nitric Acid Solution, 1:1	500 mL	254049
RoVer Rust Remover	454 g	30001
Sodium Hydroxide Standard Solution, 5.0 N	100 mL MDB	245032
Spoon, measuring, 0.1 g	each	51100



**FOR TECHNICAL ASSISTANCE, PRICE INFORMATION AND ORDERING:**  
In the U.S.A. – Call toll-free 800-227-4224  
Outside the U.S.A. – Contact the HACH office or distributor serving you.  
On the Worldwide Web – [www.hach.com](http://www.hach.com); E-mail – [techhelp@hach.com](mailto:techhelp@hach.com)

**HACH COMPANY**  
WORLD HEADQUARTERS  
Telephone: (970) 669-3050  
FAX: (970) 669-2932