

Cold Vapor Mercury Concentration Method

Method 10065

0.1 to 2.5 µg/L Hg

Scope and application: For water, wastewater and seawater.



Test preparation

Instrument-specific information

Table 1 shows all of the instruments that have the program for this test. The table also shows sample cell and orientation requirements for specific instruments.

To use the table, select an instrument, then read across to find the applicable information for this test.

Table 1 Instrument-specific information

Instrument	Sample cell orientation	Sample cell
DR 6000 DR 3800 DR 2800 DR 2700 DR 1900	The fill line is to the right.	2495402 
DR 5000 DR 3900	The fill line is toward the user.	

Before starting

The test can release toxic chlorine or other gases. Do the test procedure in a fume hood.

Use dedicated digestion glassware and sample cells for this procedure.

Determine a reagent blank for each new lot of reagent: complete the procedure, including the digestion, with 1 liter of deionized water instead of sample; add the same amount of potassium permanganate as required by the sample; subtract the reagent blank value from the final results or complete a reagent blank adjust.

Review the Safety Data Sheets (MSDS/SDS) for the chemicals that are used. Use the recommended personal protective equipment.

Dispose of reacted solutions according to local, state and federal regulations. Refer to the Safety Data Sheets for disposal information for unused reagents. Refer to the environmental, health and safety staff for your facility and/or local regulatory agencies for further disposal information.

Items to collect

Description	Quantity
Refer to Consumables and replacement items on page 11 for a complete list of required apparatus	–
Cold Vapor Mercury Apparatus Set	1
Cold Vapor Mercury Reagent Set (refer to Consumables and replacement items on page 10)	1
Digestion Reagents and Apparatus (refer to Consumables and replacement items on page 12)	varies
Sample cells (For information about sample cells, adapters or light shields, refer to Instrument-specific information on page 1.)	2

Refer to [Consumables and replacement items](#) on page 10 for order information.

Sample collection

- Collect 1000 mL of sample in an analytically clean, glass or polyethylene terephthalate (PET) container.
- To preserve samples for later analysis, add 10 mL of concentrated hydrochloric acid to the sample container before collection.
Note: Close the glass container with a ground glass stopper. Close a PET container with a PET cap or a polypropylene cap (no liner).
- Fill the bottle completely full, then tighten the cap on the bottle.
- Keep the preserved samples at 2–6 °C (35.6–43 °F) for a maximum of 6 months.
- Correct the test result for the dilution caused by the volume additions.

System start-up

For more accurate results and system equilibration, complete several analyses on mercury standards and blanks before the sample testing. This allows the system to stabilize before processing samples.

Standard start-up

1. Follow the procedure [Standard solution method](#) on page 9. If the value is not within the specified limits, continue to the next step.
2. Use a pipet to add 10.0 mL of the 0.1-mg/L mercury standard solution into the purged solution in the Gas Washing Bottle. Immediately put the stopper in the Gas Washing Bottle.
3. Use the test procedure to measure the concentration of the standard. Start at step [3](#) of phase 2.
4. Test the eluate as described in phase 3. The concentration must be 0.9–1.1 µg/L Hg. Do steps [1](#) to [3](#) again if the value is not within these limits.

Blank start-up

After a satisfactory Standard start-up is complete, use the purged solution in the Gas Washing Bottle to do a system Blank start-up.

1. Keep the purged solution in the Gas Washing Bottle. Do not add an aliquot of mercury standard.
2. Use the test procedure to measure the concentration of the sample. Start at step [3](#) of phase 2.
3. Test the eluate as described in phase 3. The concentration must be ≤ 0.2 µg/L Hg. Do the Blank start-up procedure again until a reproducible value is shown.

Phase 1: Sample digestion

⚠ WARNING



Gas inhalation hazard. Operate the instrument in a fume hood to prevent exposure to hazardous gas.

⚠ CAUTION



Chemical exposure hazard. Obey laboratory safety procedures and wear all of the personal protective equipment appropriate to the chemicals that are handled. Refer to the current safety data sheets (MSDS/SDS) for safety protocols.



1. Measure 1 liter of the sample into a 2000-mL Erlenmeyer flask.

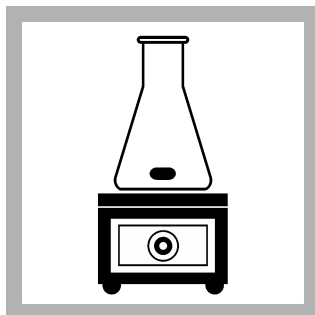

2. Put the flask on a magnetic stirring hot plate. Add a 50-mm magnetic stir bar to the sample. Set the stirrer power to on.

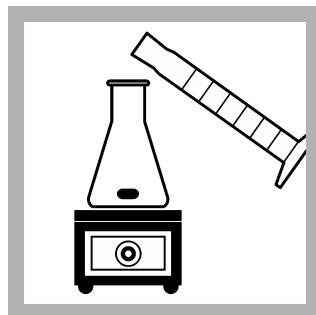

3. Add 50 mL of concentrated sulfuric acid to the sample.

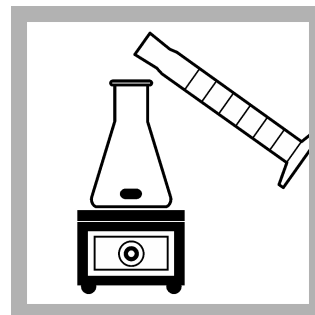

4. Add 25 mL of concentrated nitric acid to the sample.

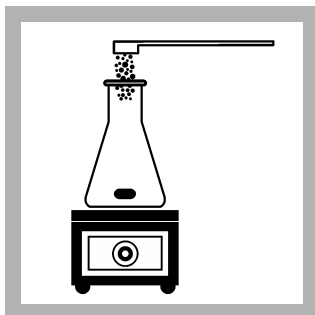

5. Add 4.0 g of potassium persulfate to the sample. Alternatively, add one 5 gram measuring scoop of potassium persulfate to the sample. Stir until dissolved.

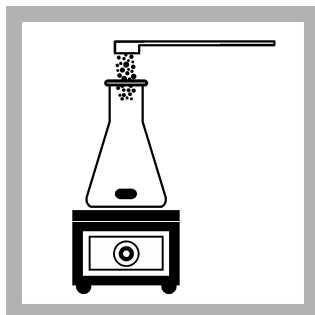

6. Add 7.5 g of potassium permanganate to the sample. Alternatively, add a 10 gram measuring scoop of potassium permanganate to the sample. Stir until dissolved.

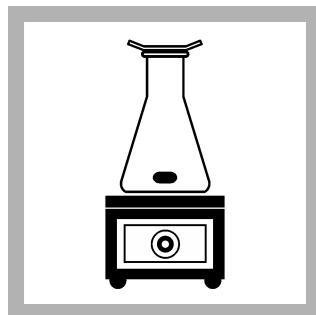

7. Use a watch glass as the flask cover. After the reagents dissolve, increase the temperature of the sample to 90 °C (194 °F). **Do not boil.**
Note: It is not necessary to increase the temperature for a mercury standard or reagent blank in distilled water.



8. Continue to stir and keep the sample temperature at 90 °C for 2 hours. The solution must stay dark purple during the entire digestion. Some samples (e.g., seawater, industrial effluents or samples that are high in organic matter or chloride) require additional permanganate. It can be difficult to see a dark purple color if the sample contains black/brown manganese dioxide precipitate. Add more potassium permanganate if the solution is not dark purple.



9. Set the hot plate power to off. Let the temperature of the digested sample decrease to room temperature.

A brown/black precipitate of manganese dioxide can form during this step. If the digested sample does not have a purple color, the digestion is not complete. Add more potassium permanganate. Put the sample back on the stirring hot plate and continue the digestion until the sample has a purple color.

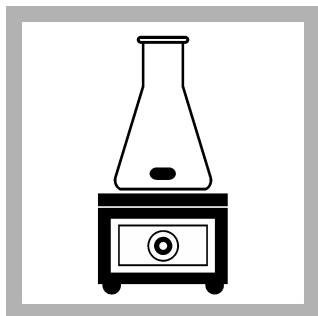

10. Put the cool digested sample on the cool stirring hot plate. Set the stirrer power to on.

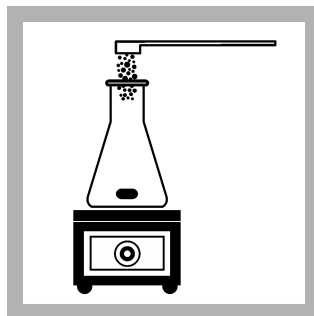

11. Add hydroxylamine-hydrochloride until all manganese dioxide is dissolved. Use a 0.5-g measuring spoon to add 0.5 g additions of hydroxylamine-hydrochloride until the purple color is gone. Wait 30 seconds after each addition and look for the color change.

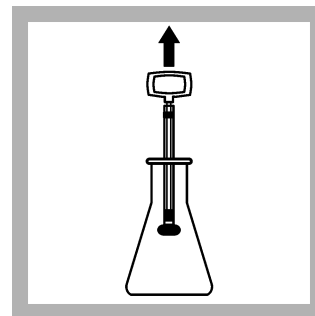

12. Remove the stir bar. The digested sample is now ready for the cold vapor separation and preconcentration procedure.

Go to [Phase 2: Cold vapor separation and preconcentration of mercury](#) on page 4.

Phase 2: Cold vapor separation and preconcentration of mercury

⚠ WARNING



Gas inhalation hazard. Operate the instrument in a fume hood to prevent exposure to hazardous gas.

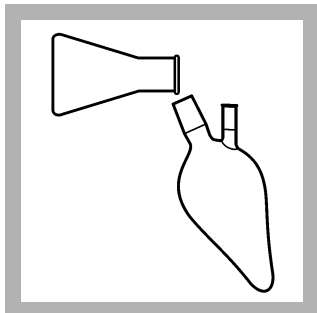

1. Pour the digested sample into the Cold Vapor Gas Washing Bottle.

Note: The volume of the digested sample must contain 0.1 to 2.5 μg Hg.

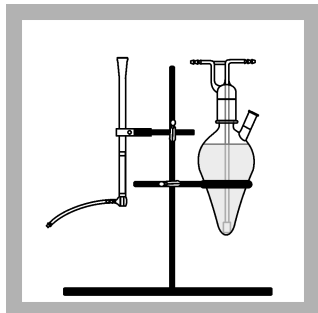

2. Set the Gas Washing Bottle in the support ring. Place the top on the Gas Washing Bottle. Wait until step 9 to connect the mercury absorber column to the Gas Washing Bottle.

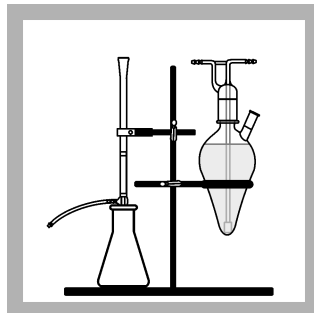

3. Connect the 100-mL Erlenmeyer flask to the mercury absorber column.

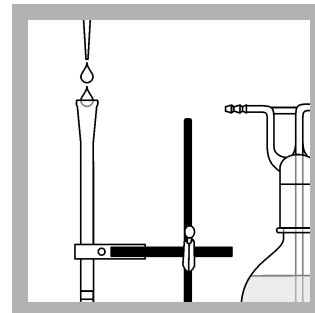

4. Pipet 8 mL of HgEx Reagent B into the Mercury Absorber column.

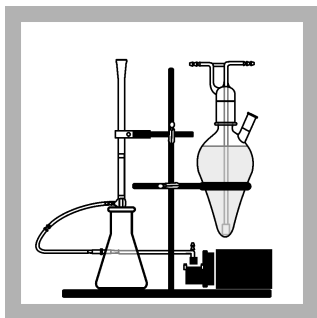

5. Apply a vacuum to the Mercury Absorber Column. Pull most of the HgEx Reagent B into the Erlenmeyer flask.

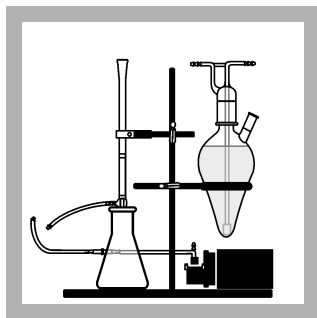

6. Use the quick disconnect to disconnect the vacuum pump when HgEx Reagent B starts to drip from the inner delivery tube on the Mercury Absorber Column (approximately 10 seconds after starting the vacuum). Make sure to not pull too much air through the Mercury Absorber Column, to prevent drying the packing.

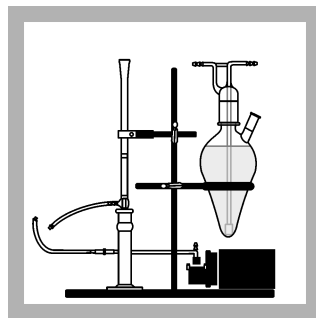

7. Remove the 100-mL Erlenmeyer flask from the Mercury Absorber Column. Replace it with the 10-mL Distilling Receiver.

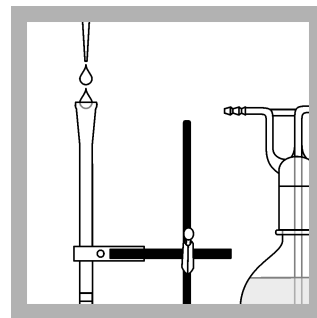

8. Pipet 2 mL of HgEx Reagent C into the Mercury Absorber Column.

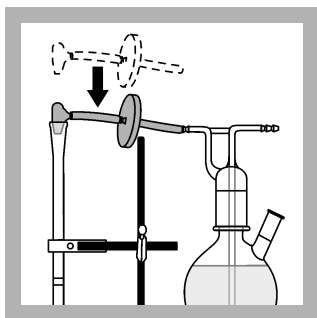

9. Use the glass elbow to connect the Mercury Absorber column to the Gas Washing Bottle.

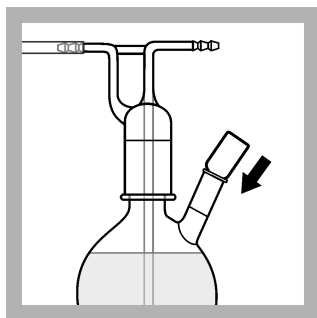

10. Shake an ampule of HgEx Reagent A to suspend undissolved reagent. Open the ampule and carefully pour the contents into the Gas Washing Bottle through the side neck.

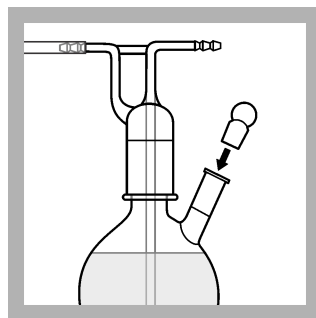

11. Put the stopper on the side neck of the Glass Washing Bottle.

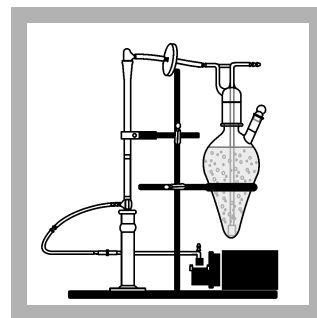

12. Use the quick disconnect to connect the vacuum pump to the Mercury Absorber Column again. Apply the vacuum to pull HgEx Reagent C through the Mercury Absorber Column packing and into the 10-mL receiver. Air bubbles should be produced at the gas dispersion tube in the Gas Washing Bottle. Complete the next two steps immediately.



Start



05:00

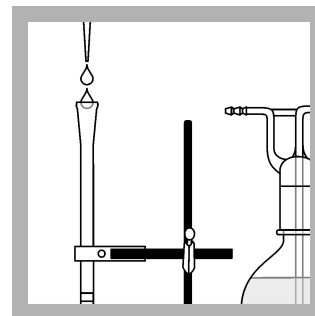
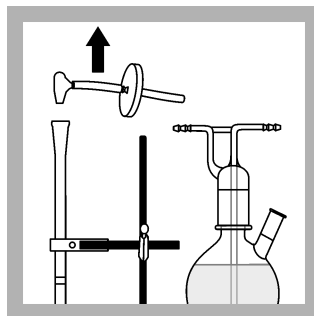

13. Start program 312 Mercury, Cold Vap.

For information about sample cells, adapters or light shields, refer to [Instrument-specific information](#) on page 1.

Note: Although the program name can be different between instruments, the program number does not change.

14. Start the instrument timer. A 5-minute reaction time starts. Let the solution bubble for this period. The air flow rate through the Gas Washing Bottle should be between 1-5 L/min. Let the solution bubble for more time when the air flow rate is low. For example, if the air flow rate is 1 L/min., let the solution bubble for 10 minutes.

15. After the timer expires, remove the glass elbow from the top of the Mercury Absorber Column. Keep the vacuum pump power on.

16. Pipet 8 mL of HgEx Reagent B into the Mercury Absorber Column to elute the captured mercury. Continue to apply the vacuum to pull the HgEx Reagent B into the Distilling Receiver.

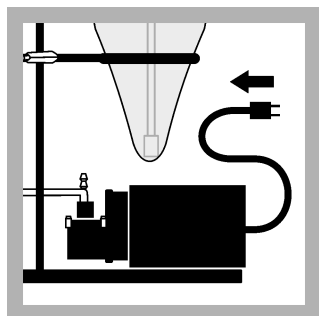

17. Set the vacuum pump to off when the volume in the Distilling Receiver is at the 10-mL mark. If necessary, adjust the volume in the Distilling Receiver a maximum of 10 mL with HgEx Reagent B.

To prevent low volumes in the future, disconnect the vacuum sooner in step 6. This leaves more HgEx Reagent B in the packing of the Mercury Absorber Column.

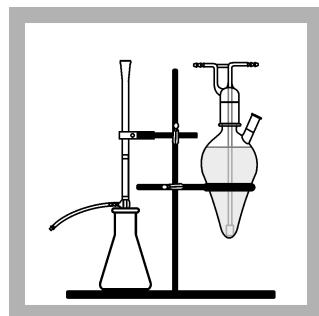

18. Remove the distilling Receiver from the Mercury Absorber Column. Connect the 100-mL Erlenmeyer flask to the column again.

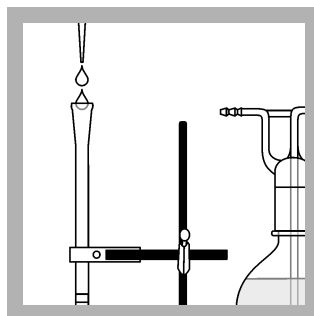

19. Use a pipette to add 3 mL of HgEx Reagent B into the Mercury Absorber Column without applying vacuum. This keeps the absorber packing wet between tests.

The Mercury Absorber Column eluate in the Distilling Receiver is ready for analysis.

Go to [Phase 3: Colorimetric analysis](#) on page 7.

Phase 3: Colorimetric analysis

⚠ WARNING



Gas inhalation hazard. Operate the instrument in a fume hood to prevent exposure to hazardous gas.

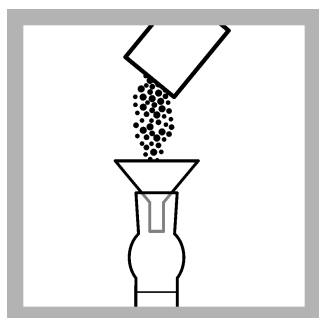

1. Use the supplied funnel to add the contents of one HgEx Reagent 3 foil pillow to the eluate in the Distilling Receiver.

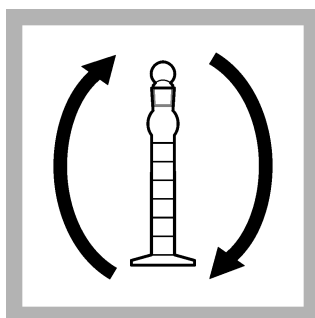

2. Put the stopper on the receiver. Invert to dissolve the reagent.

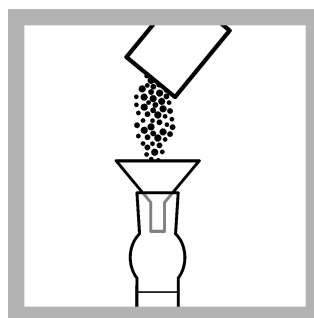

3. Use the supplied funnel to add the contents of one HgEx Reagent 4 foil pillow to the Distilling Receiver.

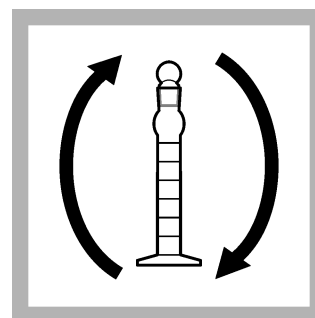

4. Put the stopper on the receiver. Invert to dissolve the reagent.

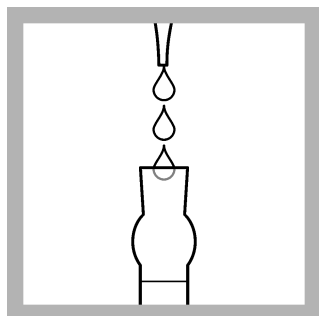

5. Add 8 drops of HgEx Reagent 5 to the Distilling Receiver.

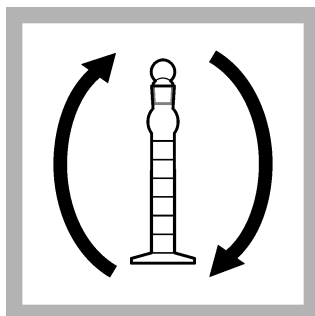

6. Put the stopper on the receiver. Invert to mix the reagent.



7. Start the instrument timer. A 2-minute reaction time starts.

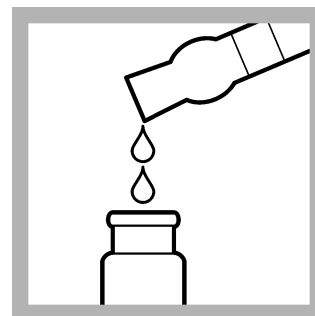

8. During the reaction period, pour the solution into a sample cell.

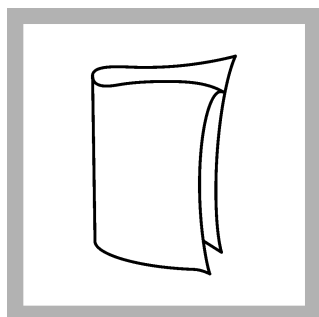

9. Clean the prepared sample cell.

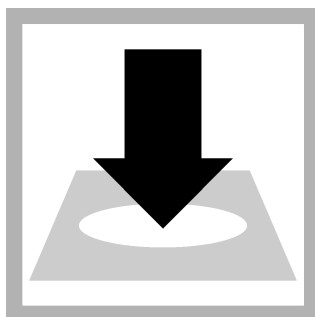

10. Insert the sample cell into the cell holder.

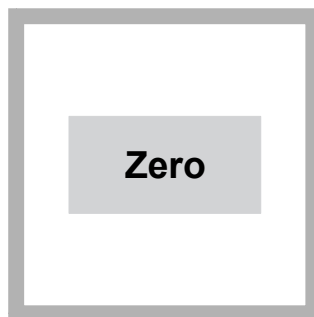

11. Push **ZERO**. The display shows 0.1 $\mu\text{g/L}$ Hg (this program uses a non-zero intercept).

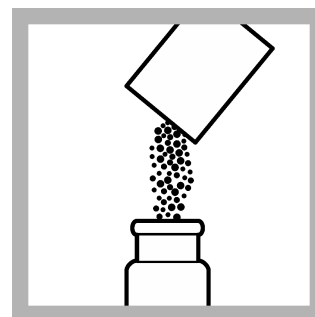

12. Remove the cell from the cell holder. Add the contents of one HgEx Reagent 6 foil pillow to the solution.
Note: Do not use the funnel to add HgEx Reagent 6 to the sample cell. HgEx Reagent 6 contamination from the funnel will make it impossible to find mercury in subsequent tests.

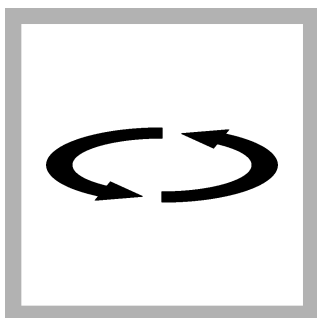

13. Swirl the cell until the reagent is completely dissolved. Immediately continue with next step .

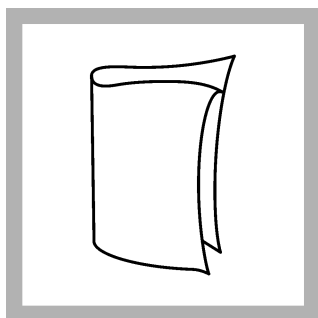

14. Clean the prepared sample cell.

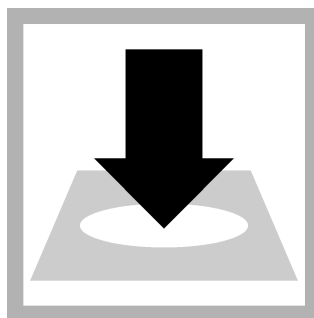

15. Insert the prepared sample into the cell holder.

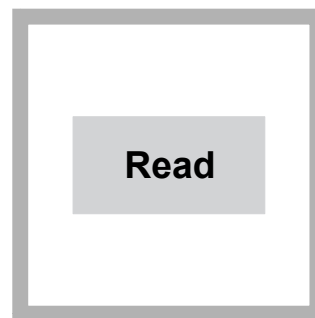

16. Push **READ**. Results show in $\mu\text{g/L}$ Hg. This is the concentration in the original sample.

Interferences

Standards were used to prepare a single test solution with substances at the concentrations shown in [Table 2](#). A second test solution containing only mercury at the same concentration was prepared as the control. The two solutions were digested, then analyzed concurrently. There was no interference from the matrix of the test solution at the concentrations listed.

In addition, no interference occurred with a test solution containing 1000 mg/L Na^+ , 1000 mg/L K^+ , 1000 mg/L Mg^{2+} and 400 mg/L Ca^{2+} .

Table 2 Interfering substances

Interfering substance	Interference level
Ag^+	7 mg/L
Al^{3+}	10 mg/L
Au^{3+}	500 $\mu\text{g/L}$
Cd^{2+}	10 mg/L
Co^{2+}	10 mg/L
Cr^{6+}	10 mg/L
Cu^{2+}	10 mg/L
F^-	1.0 mg/L
Fe^{2+}	100 mg/L
Mo^{6+}	10 mg/L
Ni^{2+}	10 mg/L
$\text{NO}_3^- - \text{N}$	50 mg/L
Pb^{2+}	10 mg/L
SiO_2	100 mg/L
Zn^{2+}	10 mg/L

Accuracy check

Standard additions method

Use the standard additions method (for applicable instruments) to validate the test procedure, reagents and instrument and to find if there is an interference in the sample.

Items to collect:

- 1000-mg/L Mercury Standard Solution

-
- 500-mL volumetric flask
 - 10-mL volumetric pipet and pipet bulb
 - Pipet, TenSette®, 0.1–1.0 mL and tips
 - Deionized water
1. Prepare a 10.0-mg/L mercury standard as follows:
 - a. Use a pipet to add 5.00 mL of a 1000-mg/L Mercury Standard Solution into a 500-mL volumetric flask.
 - b. Use a pipet to add 1.0 mL of concentrated nitric acid to the flask.
 - c. Dilute to the mark with deionized water. Mix well.
 2. Use a TenSette Pipet to add 0.10 mL of the 10.0-mg/L mercury standard to the purged solution in the Gas Washing Bottle after an analysis has been completed. Immediately put the stopper on the Gas Washing Bottle.
 3. Use the test procedure to measure the concentration of the sample. Start at step 3 of Phase 2.
 4. Test the eluate as described in Phase 3. The expected result is 0.9–1.1 µg/L Hg.

Standard solution method

Use the standard solution method to validate the test procedure, the reagents and the instrument.

Items to collect:

- 1000-mg/L Mercury Standard Solution
 - 100-mL and 500-mL volumetric flask
 - Concentrated sulfuric and nitric acid
 - Pipet, TenSette®, 0.1–1.0 mL and tips
 - Deionized water
1. Prepare a 10.0-mg/L mercury standard solution as follows:
 - a. Use a pipet to add 5.0 mL of a 1000-mg/L Mercury Standard Solution into a 500-mL volumetric flask.
 - b. Use a pipet to add 1.0 mL of concentrated nitric acid.
 - c. Dilute to the mark with deionized water. Mix well.
 2. Prepare a 1.0-mg/L mercury standard solution as follows:
 - a. Use a pipet to add 10.0 mL of the prepared 10.0-mg/L mercury standard solution into a 100-mL volumetric flask.
 - b. Use a pipet to add 0.2 mL of concentrated nitric acid.
 - c. Dilute to the mark with deionized water. Mix well.
 3. Prepare a 0.1-mg/L mercury standard solution as follows:
 - a. Use a pipet to add 10.0 mL of the prepared 1.0-mg/L mercury standard into a 100-mL volumetric flask.
 - b. Use a pipet to add 0.2 mL of concentrated nitric acid.
 - c. Dilute to the mark with deionized water. Mix well.
 4. Pour 800 mL of deionized water into the Gas Washing Bottle.
 5. Add 50 mL of concentrated sulfuric acid and 25 mL of concentrated nitric acid to the Gas Washing Bottle. Swirl to mix.
 6. Use a pipet to add 10.0 mL of the 0.1-mg/L mercury standard solution into the Gas Washing Bottle. Swirl to mix.
 7. Use the test procedure to measure the concentration of the sample. Start at step 2 of Phase 2.
 8. Test the eluate as described in Phase 3. The expected result is 0.9–1.1 µg/L Hg.

Method performance

The method performance data that follows was derived from laboratory tests that were measured on a spectrophotometer during ideal test conditions. Users can get different results under different test conditions.

Program	Standard	Precision (95% confidence interval)	Sensitivity Concentration change per 0.010 Abs change
312	1.0 µg/L Hg	0.9-1.1 µg/L Hg	0.03 µg/L Hg

Pollution prevention and waste management

The reacted samples and equipment components contain mercury and must be disposed of as a hazardous waste. Dispose of reacted solutions according to local, state and federal regulations.

Summary of method

The sample is digested to change all the mercury in the sample to mercuric (Hg^{2+}) ions. The mercuric ions in the digested sample becomes a gas in a semi-closed system. The ambient air moves the vapor into a chemically-activated absorber column where the mercury vapor reacts to form mercuric chloride.

The mercuric chloride is eluted off the column and a sensitive indicator is added. The instrument is zeroed at the absorbance peak of the unreacted indicator. A complexing agent is added to break the mercury:indicator complex. The increase in unreacted indicator causes an increase in absorbance proportional to the amount of mercury in the original sample. Test results are measured at 412 nm.

Storage and maintenance of the cold mercury apparatus

Storage

For the fastest system stabilization and greatest sensitivity, put the apparatus in storage as follows:

- Keep the Gas Washing Bottle filled with deionized water and 15 mL of concentrated sulfuric acid. Seal the bottle with the Gas Washing Bottle stopper and top.
- Keep the Mercury Absorber Column with the packing wetted with HgEx Reagent B. Keep the Erlenmeyer flask attached below the column. Attach the top of the Mercury Absorber column to the Gas Washing Bottle with the glass elbow as in the procedure.

Maintenance

- Use dedicated glassware and sample cells.
- Fully clean the glassware and sample cells between tests. Rinse with 1:1 hydrochloric acid solution, then rinse several times with deionized water.

With correct maintenance, the Mercury Absorber Column can be used an unlimited number of times.

- Replace the Mercury Scrubber in the air trap housing at least once for every reagent set used.
- Moisture buildup on the Gas Washing Bottle side of the Acro 50 Vent Filter will reduce the purging air flow rate. If this occurs, replace the filter or dry it in an oven at 110 °C (230 °F).

Consumables and replacement items

Required reagents

Description	Quantity/test	Unit	Item no.
Cold Vapor Mercury Reagent Set (25 tests), includes:			2658300
HgEx™ Reagent A, Stannous Sulfate Solution, 20-mL ampules	1	25/pkg	2658825
HgEx™ Reagent B, Sulfuric Acid Solution	19 mL	500 mL	2658949

Consumables and replacement items (continued)

Description	Quantity/test	Unit	Item no.
HgEx™ Reagent C, Sodium Hypochlorite Solution	2 mL	55 mL	2659059
HgEx™ Reagent 3, Alkaline Reagent Powder Pillows	1 pillow	25/pkg	2658448
HgEx™ Reagent 4, Indicator Powder Pillows	1 pillow	25/pkg	2658548
HgEx™ Reagent 5, Sodium Hydroxide Solution	8 drops	10 mL SCDB	2658636
HgEx™ Reagent 6, Complexing Reagent Powder Pillow	1 pillow	25/pkg	2658748
Mercury Scrubber	2/reagent set	2/pkg	2655800

Required apparatus

Description	Quantity/test	Unit	Item no.
Cylinder, graduated, 50-mL	1	each	50841
Pipet, TenSette®, 0.1–1.0 mL	1	each	1970001
Pipet, TenSette®, 1.0–10.0 mL	1	each	1970010
Pipet Tips, for TenSette® Pipet, 0.1–1.0 mL	2	50/pkg	2185696
Pipet Tips, for TenSette® Pipet, 1.0–10.0 mL	varies	50/pkg	2199796
Vacuum Pump, 1.2 CFM 115 V	1	each	2824800
Vacuum Pump, 230 VAC w/ North American Plug	1	each	2824801
Vacuum Pump, 230 V w/ European Plug	1	each	2824802
Cold Vapor Mercury Apparatus Set, includes:			2674400
Acro 50 Vent Filter	1	18/pkg	2683318
Air Trap Holder Assembly	1	each	2663900
Ampule breaker	1	each	2564000
Breaker/Capper Tool for Mercury Scrubber	1	each	2664000
C-flex Tubing, 0.25-inch ID, white	4 ft	25 ft	2327367
Clamp for Mercury Absorber Column	1	each	2656200
Clamp Holder	2	each	32600
Sample cell, 10-mL square, matched pair	2	2/pkg	2495402
Riser Cell, 1" Square DR2000/2010	1	each	4528200
Riser cell, 1", Square DR3000	1	each	4840300
Distilling Receiver, 10-mL	1	each	2655438
Flask, Erlenmeyer, 100-mL	1	each	2655342
Funnel, micro, poly	1	each	2584335
Gas Washing Bottle, 1200-mL	1	each	2662200
Glass Elbow, 90-degree, with hose adapter	1	each	2655200
Mercury Absorber Column	1	each	2655510
Support Ring for Gas Washing Bottle	1	each	2656300
Stopper, for Distilling Receiver	1	each	2655900
Stopper, for Gas Washing Bottle	1	each	2662300
Support, Base and Rod	1	each	32900
Tubing Quick Disconnect, HDPE	1	12/pkg	1481000

Required digestion reagents and apparatus

Description	Quantity/test	Unit	Item no.
Flask, Erlenmeyer, 2000-mL	1	each	2489454
Hot plate, stirrer, 115 VAC	1	each	2881600
Hot plate, stirrer, 220–240 VAC	1	each	2881602
Hydroxylamine Hydrochloride, ACS	varies	113 g	24614
Nitric Acid, ACS	25 mL	500 mL	15249
Potassium Permanganate, ACS	varies	454 g	16801H
Potassium Persulfate, ACS	4.0 g	454 g	2617501
Sulfuric Acid, concentrated, ACS	75 mL	2.5 L	97909
Spoon, measuring, 0.5 g	1	each	90700
Stir Bar, Octagonal 50.8 x 7.9 mm	1	each	2095355
Thermometer, -20 to 110 °C	1	each	56601
Watch Glass, Pyrex, 65 mm	1	each	57867

Recommended standards

Description	Unit	Item no.
Mercury Standard Solution, 1000-mg/L Hg (NIST)	100 mL	1419542
Water, deionized	4 L	27256



FOR TECHNICAL ASSISTANCE, PRICE INFORMATION AND ORDERING:
In the U.S.A. – Call toll-free 800-227-4224
Outside the U.S.A. – Contact the HACH office or distributor serving you.
On the Worldwide Web – www.hach.com; E-mail – techhelp@hach.com

HACH COMPANY
WORLD HEADQUARTERS
Telephone: (970) 669-3050
FAX: (970) 669-2932